

# Tapiflex Stairs

HETEROGENEOUS VINYL

A safer  
step

 **100%**  
phthalate-free

# CONTENTS

**CREATE DISTINCT SPACES FROM FLOORS TO WALL** 3

---

**A CONCENTRATION OF TECHNOLOGIE** 4

---

**STEP CONFIDENTLY** 5

---

**SPEED INSTALL STEP AFTER STEP** 7

---

**SMART DESIGN USING COLOUR** 9

---

**ONE SOLUTION FOR YOUR ENTIRE PROJECT** 11

---

**SIMPLE STEPS TO LONG-LASTING STAIRS** 12

---

**A METHODOICAL APPROACH TO CLEANING** 13

---

**TAPIFLEX STAIRS TENDER SPECIFICATION** 14

---

**TECHNICAL DATA SHEET** 15

---



**TAPIFLEX STAIRS**  
 FUSION LINES STAIRS - DARK GREY 025  
 FUSION LINES STAIRS - PHOSPHO 024

**EXCELLENCE**  
 WASHED OAK - WHITE 817

## CREATE DISTINCT SPACES FROM FLOORS TO WALL

Tarkett's Stairs collection gives safety pride of place on all stairs. Cost-effective, resistant and now self-adhesive for ten references, it is also 100% phthalate-free, like all Tarkett HE premium collections.

The self-adhesive backing saves both time and budget. They install 30% faster than traditional glued products, and don't require any glue.

Once they've been installed, test them out. You'll see that Tarkett Stairs absorb up to 18dB of sound, cushion impact thanks to their elastic foam backing and fully resist indentation.

Compliance follows comfort. The majority of designs achieving 70% contrasts levels, Tarkett Stairs easily meet all building and safety standards.

And with over 20 references that mix and match with all of Tarkett's HE collections, make your design coherent throughout all parts of a building. A wide selection of accessibility options and accessories also exists to ensure autonomy and facilitate orientation within a building.

### DESIGN

 **20+**  
stairs  
references

### Add high contrast flash

 **5 new neon phosphorescent**  
stair nose references

 Full Floor, Wall & Stairs  
coordination

### PERFORMANCE

 **Comfortably hard-wearing**  
  
**Tapiflex Stairs\***  
cushion footfall while resisting indentation  
**0.10mm / 18dB**

 **Safety for users**  
 · **Contrasted stair noses** compliant with regulations  
 · **70% contrast selection**

 **The only self-adhesive stair coverings**  
 · Reduce installation time by **30%**  
 · **Staircases stay open during** step by step installation & renovation  
 · **Immediately available for use after installation**  
 · **Safe dry glue**

\* resistance to indentation / sound impact reduction

# A CONCENTRATION OF TECHNOLOGY

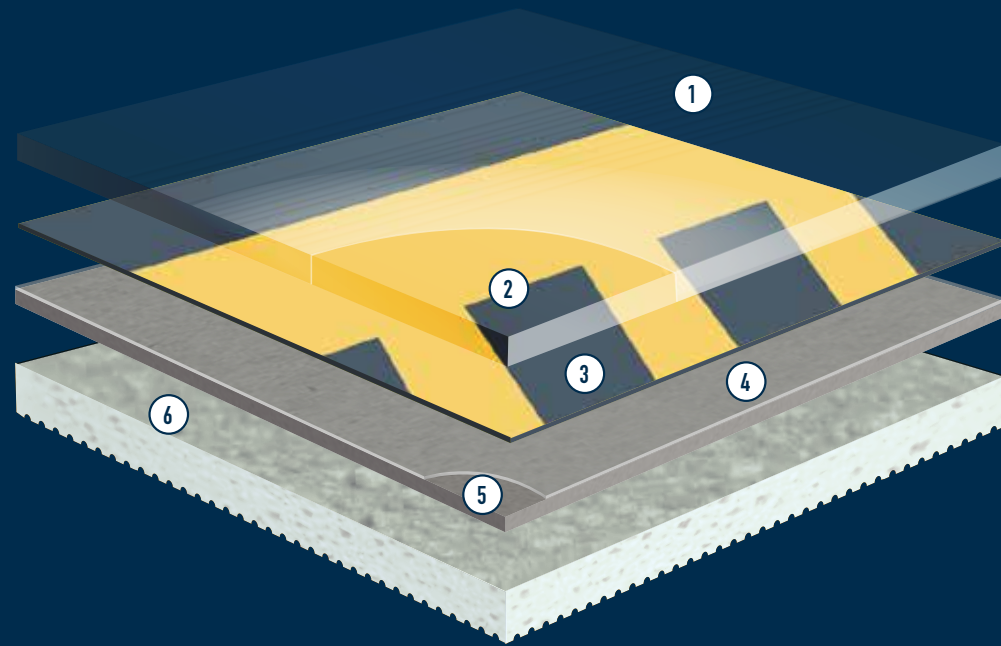

**1** PUR treatment is a photo-reticulated coating that is highly resistant to abrasion and scratches.

**2** Pure PVC transparent wear layer of 1 mm for the best resistance to traffic and wear

**3** High quality printed designs for a vast selection of colours and patterns

**4** High density glass fibre non-woven reinforcement for high dimensional stability and resistance to furniture

**5** Solid homogeneous calendered sheet made of recycled vinyl for resistance to indentation and tearing

**6** Density closed-cell foam backing for sound reduction, and underfoot comfort

# STEP CONFIDENTLY

With Tarkett Tapiflex Stairs installed, building occupants are ensured of their safety when taking the stairs. Visible contrast, non-slip ridges, comfort when climbing and highly resistant wear greet feet step after step.



As public buildings, hospital buildings are required by an international directive (ISO 21542 for building conception) to be accessible to disabled people, and visually impaired people in particular require help in navigating space. A Light Reflective Value (LRV) of 30% improves visual cues, and 60% is recommended for danger, important information and logos.

**Good visibility guaranteed at 70% LRV** between stair noses and steps

**16 Stairs references have an LRV  $\geq 70\%$**



Tapiflex Stairs' special design includes built-in ridges to improve slip resistance and visually define each step.

**Stair nose integrated into the product**

Built-in ridges	14.25	51	102cm
	12.5		
	24.5		
Built-in ridges	24.5	51	
	12.5		
	14.25		

100cm length = 2 straight steps



The elastic foam backing absorbs noise and provides underfoot comfort, whether going up or down.

**18dB sound reduction**



Tapiflex is coated with Tarkett's PUR treatment. Stairs resist stains and are easy to clean. There is also a thick wear layer for added durability.

**1 mm pure PVC wear layer**

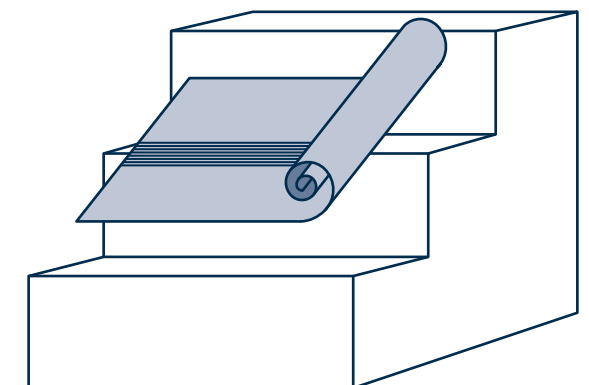



PROTECTWALL  
TISSE - FRESH GREEN 028



TAPIFLEX STAIRS  
CONCRETE STAIRS - COOL GREY 000  
NEON STAIRS - BRIGHT ANIS 028

EXCELLENCE  
CARPET - INTENSE OLIVE 106

## SPEED INSTALL SELF ADHESIVE OPTION

Ten Tapiflex Stairs references come with a self-adhesive backing to facilitate and quicken installation. The stair coverings are delivered as separate steps. Installed horizontally, stairs can stay accessible while Tapiflex is positioned.

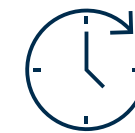

### Faster Time to the Top

The glue on Tapiflex Stairs requires no waiting time.

**30% faster  
installation**

For installation  
of 15 steps

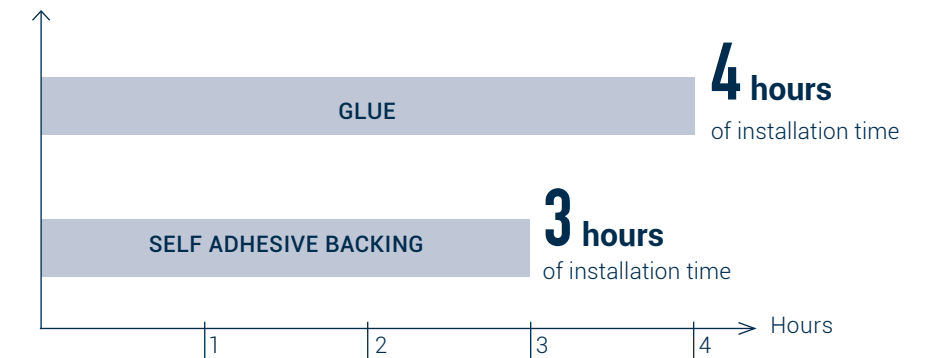

### One Step at a Time

Stairs remain open to passing feet during the time it takes to install Tapiflex. Working step by step, renovation is much easier if a step is damaged.

### Free circulation during installation

### Step by step installation

### Step Right Up

Once in place, stairs can be used immediately. There is no need to wait for the adhesive to dry.

### Use immediately



### Glue Included

No additional glue is required during installation, since each step already has safe dry glue on its back. A protective film separates steps from each other, making unpacking easy.

### Ready-to-use, safe dry glue



# Resto

## SMART DESIGN USING COLOUR

Tapiflex Stairs has a generous range of colours and contrasts with which to identify different parts of buildings, orient occupants, and most of all increase safety.

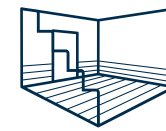

### Mix and Match

Give the whole building a coherent design by mixing and matching Tapiflex Stairs with Tarkett's other HE collections.



### 20+ references



### 5 NEW & unique phosphorescent stair noses

see stair edges in the dark



### The Visual Cues are in the Details

Colour plays a fundamental role in helping everyone in navigating a building safely, and in particular people with various sensorial, physical or mental impairments. Acting as a guide, colour and contrast identify and separate distinct spaces, provide building orientation and ensure safety for building occupants.

- ✓ Identify
- ✓ Orient
- ✓ Separate
- ✓ Be safe

### Personalise Using Floorcraft

Tarkett's Floorcraft service offers a comprehensive range of standard elements and logos to incorporate directly into to create signage and facilitate accessibility.

- Standard designs, adapt colours for individual projects
- Customised logos and designs



CONTRAST RATE	TAPIFLEX STAIRS	PERFECT MATCH WITH TAPIFLEX EXCELLENCE
77%		
	Tissage soft grege 128	Tissage soft grege 128
75%		
	Oak tree beige 200	Oak tree beige 200
74%		
	Neon Bright Ice Blue 029	Uni bright ice blue 932
72%		
	Fusion Lines Phospho 024	Fusion Lines Phospho 171

TAPIFLEX STAIRS  
UNI STAIRS - BRIGHT ICE BLUE 122  
NEON STAIRS - BRIGHT ICE BLUE 029

EXCELLENCE  
UNI - BRIGHT ICE BLUE 932





# ONE SOLUTION FOR YOUR ENTIRE PROJECT

Stairs, ProtectWall, Platinum and Excellence are all designed to work together. With Tarkett's HE collections, you can create one coherent harmonised design concept for all parts of your project, complete with patterns that combine in each of the collections. Explore and install the full solution!

**Wetroom Concept**  
For a watertight design solution  
(Floor: 89 colour references  
Wall: 77 colour references)

**Tapiflex Stairs**  
For increased safety  
(22 colour references)

**ProtectWall**  
For maximum impact,  
stain & scratch resistance  
(50 colour references)

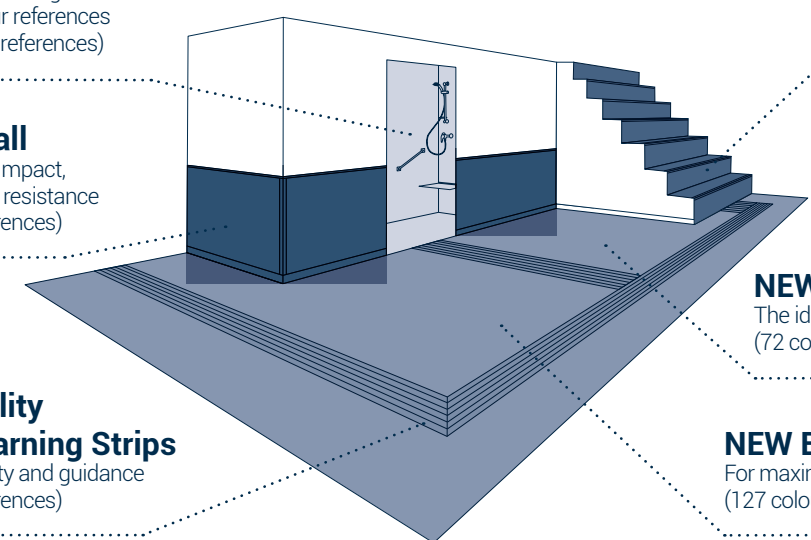

**NEW Platinum**  
The ideal heavy traffic solution  
(72 colour references)

**Accessibility Tactile Warning Strips**  
To ensure safety and guidance  
(17 colour references)

**NEW Excellence**  
For maximum design possibilities  
(127 colour references)

Design	Colour	NCS stair	LRV stair (%)	NCS stair nose	LRV stair nose (%)	Contraste	TAPIFLEX STAIRS	TAPIFLEX STAIRS SA	EXCELLENCE	PLATINIUM	PROTECTWALL
CONCRETE STAIRS	Cool grey	S 3500-N	36,3	S 7000-N	9,7	73%	25171000	25173000	CONCRETE Cool Grey 500	SPICE & CANDY Grey 026	CONCRETE Cool Grey 26500058
	Dark grey	S 6500-N	12,2	S 3502-B	32	62%	25171015	25173015	ESQUISSE Dark Grey 015	SALT & PEPPER Graphite 014	UNI Warm Grey 26500043
ESQUISSE STAIRS	Light Grey	S 3500-N	31,8	S 7000-N	9,6	70%	25171018	25173018	ESQUISSE Light Grey 013	SALT & PEPPER Medium Grey 009	UNI Warm Grey 26500043
	Phospho	S 4000-N	34,7	S 7000-N	9,7	72%	25172024	25174024	FUSION LINES Phospho 171	MELT Medium Grey 010	Transition Grey 26500065
FUSION LINES STAIRS	Dark Grey	S 6000-N	16,2	S 6502-B	32,7	50%	25172025	25174025	FUSION LINES Dark Grey 172	UNI Warm Grey 025	UNI Warm Grey 26500043
	Grey	S 3005-Y50R	37,6	S 7000-N	9,7	74%	25171012	25173012	GRANITO Warm Grey 110	PLAZZA Beige 023	UNI White Grey 26500132
GRANITO STAIRS	Beige	S 2005-Y30R	53,8	S 7000-N	9,7	82%	25171013	25173013	GRANITO Light Beige 109	MELT Mastic 019	UNI Light Beige 26500122
	Bright Orange	S 7000-N	25,9	S 2060-Y70R	10,3	60%	25172026	25174026	UNI Dark Grey 916	UNI Dark Grey 916	UNI Bright Orange 26500036
NEON STAIRS	Bright Yellow	S 7000-N	41,3	S 2500-Y10R	11,1	73%	25172027	25174027	UNI Dark Grey 916	UNI Dark Grey 916	UNI Bright Yellow 26500037
	Bright Anis	S 7000-N	40,4	S 2050-G90Y	11,1	72%	25172028	25174028	UNI Dark Grey 916	UNI Dark Grey 916	UNI Bright Anis 26500039
	Bright Ice Blue	S 7000-N	41,9	S 2020-B50G	10,7	74%	25172029	25174029	UNI Dark Grey 916	UNI Dark Grey 916	UNI Bright Ice Blue 26500048
	Beige	S 3010-Y20R	34,4	S 7000-N	8,6	75%	25171030	25173030	OAK TREE Beige 030	SALT & PEPPER Grege 015	UNI Light Beige 26500122
OAK TREE STAIRS	Grey	S 5005-Y20R	27,2	S 7000-N	9,7	64%	25171031	25173031	OAK TREE Grey 031	MELT Beige 020	Concrete Chalk 26500059
	Soft Grege	S 3005-Y20R	42,7	S 7000-N	9,7	77%	25171032	25173032	TISSAGE Soft Grege 032	MELT Mastic 019	UNI Light Beige 26500122
TISSAGE STAIRS UNI STAIRS	Dark Beige	S 4005-Y20R	27,7	S 7000-N	11	60%	25172116	25174116	UNI Dark Beige 918	UNI Dark Beige 918	Concrete Chalk 26500059
	Grey	S 7000-N	10,7	S 3502-B	35,6	70%	25172117	25174117	UNI Dark Grey 916	UNI Dark Grey 916	UNI Dark Grey 26500041
	Medium Alu	S 4000-N	34,5	S 7000-N	9,7	72%	25172118	25174118	STEEL Grey 601	MELT Medium Grey 010	MARBLE Carrare 26500064
	Bright Orange	S 2060-Y70R	25,9	S 6502-B	10,3	60%	25172119	25174119	UNI Bright Orange 929	SPICE & CANDY Orangeade 066	UNI Bright Orange 26500036
	Bright Yellow	S 2050-Y10R	41,3	S 7000-N	11,1	73%	25172120	25174120	UNI Bright Yellow 930	MELT Yellow 003	UNI Bright Yellow 26500037
	Bright Anis	S 2050-G90Y	40,4	S 7000-N	11,1	72%	25172121	25174121	UNI Bright Anis 931	MELT Anis 016	UNI Bright Anis 26500039
	Bright Ice Blue	S 2020-B50G	41,9	S 7000-N	10,7	74%	25172122	25174122	UNI Bright Ice Blue 932	MELT Lagoon 013	UNI Bright Ice Blue 26500048
	Medium Grey	S 3502-B	35,9	S 7000-N	10,5	71%	25172123	25174123	UNI Medium Grey 917	MELT Light Grey 009	UNI Medium Grey 26500044

## Des accessoires pour une finition parfaite

Optimize building orientation, navigation and safety with our dedicated accessories range.

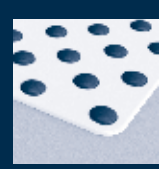

**SELF ADHESIVE STUDS**  
Ready-to-use individual podotactile studs to be installed directly onto flooring.



**WARNING TILES**  
Help identify a change in level. Available in self adhesive and to be glued versions.

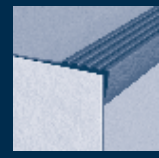

**INSIDE & OUTSIDE STAIR CORNER**  
Corners designed to form a neat and attractive edge around the open end of a step by concealing the edge of the floor covering and stair edging. Colour coordinated with PVC stair nosing.



**SELF ADHESIVE TACTILE STRIPS**  
Designed for wayfinding by the visually impaired using white support canes. Options: tactile strip or linear strip.

# SIMPLE STEPS TO LONG-LASTING STAIRS

Follow Tarkett's techniques and tips to ensure perfect installation and keep your stairs in good condition for years to come.

## STEPS IN INSTALLING

### 1. Subfloor

- Sound, hard, flat, clean, smooth, free from all types of marks and residue, and not exposed to humidity.
- Check subfloor absorbency and treat with a primer if needed so that it's moderately absorbent.
- Check that subfloor meets local standards and control methods.
- Stair noses must have a minimum radius of 12mm.

### 2. Pre-Installation

- Check that underfloor heating functions and is turned off 48 hours before installing.
- Store 1m rolls vertically and larger rolls horizontally for 24 hours.
- Work at room temperature. Acclimatise flooring for 24 hours before laying. Let cut flooring relax another 24 hours.

### 3. Installation

- With a finely notched spatula or roller, apply acrylic contact adhesive to each tread, nose and riser, starting from the top. Coat the reverse of each piece of pre-cut flooring at the same time. Let dry.

- Start at the bottom of the staircase. Position Tapiflex Stairs so that the fine ribs are spread evenly over the stair nose, and the broad ribs over the treads. Align with a reference mark on the substrate to position the ribs properly.
- Distribute ribs 1/3 on riser and 2/3 on tread.
- Press floor covering firmly onto the adhesive, especially over the nosing detail. Roll carefully from the nose over the tread and up the riser.
- For turning stairs, use a stair bevel to facilitate installation.

### 4. Welding

- Cold weld where tread and riser meet, following instructions and precautions for use.

### After Installation

- Clean up all adhesive marks, stains and dust. Cover newly installed stairs with cardboard to protect them.
- Open area to normal traffic 48 hours after installation.

### Landing Junctions

- Where the staircase and landing meet, join flooring at the last broad rib, furthest from the stair nose.
- Hot weld with 4mmPVC welding rod. Groove 2/3 of the compact layer and weld with a hot speed nozzle.
- Trim the welding rod immediately and after 5 minutes with a Mozart knife.

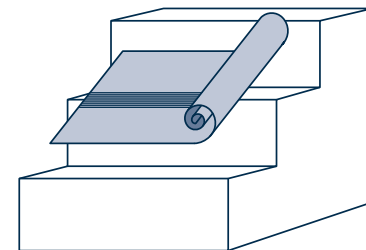

Consult documentation online for more exhaustive information about transporting, preparing and installing new flooring. You may also contact your Tarkett representative.

Tarkett accepts no liability for adhesives and levelling compounds used, including those recommended.

# A METHODOICAL APPROACH TO CLEANING

Tarkett's PUR surface treatment facilitates cleaning and decreases the need for water and solvents, reducing environmental impact. Regular and attentive cleaning maintains flooring in between periodic deep-clean buffing sessions.

## General Advice

- Clean the floorcovering regularly, as this is more cost-effective and hygienic than occasional heavy-duty cleaning.
- Black rubber wheels and rubber feet can discolour the floorcovering. All chair and table legs should have good quality floor protectors. Felt pads are not recommended in commercial interiors. Hard plastic is preferred.
- Install doormats at the entrance of the buildings to catch humidity, dirt, dust etc. They must be at least three strides long (approx. 1.5 m).
- Always follow manufacturers' recommendations (detergent, cleaning machine...).

SETTING IN TRAFFIC	ACTIONS	INSTRUCTIONS
	<b>1. Removing dust and gravel</b>	– Dry mopping. – Vacuum cleaning.
	<b>2. Cleaning</b>	– Mechanical cleaning with scrubbing machine – red pad, medium speed – and water vacuuming, or combined machine. – Use neutral detergent (pH 6/8) or alkaline detergent (pH 8/12) in case of heavy soiling. – If an alkaline detergent (pH 8/12) is used, the flooring should be rinsed with water and water vacuumed.
	<b>3. Stain removal</b>	– A detergent should be used to remove work-site stains (glue, paint...) according to the nature of the stain. – Do not use abrasive pads.
DAILY CLEANING	ACTIONS	INSTRUCTIONS
	<b>1. Removing dust and gravel</b>	– Dry mopping. – Vacuum cleaning.
	<b>2. Cleaning (if and where it's necessary)</b>	– With flat or micro fibre mop, impregnated or not. or – With a combined machine (red pad, medium speed). – Use neutral detergent (pH 6/8).
	<b>3. Stain removal</b>	– For stubborn stains on the floor, use an alkaline detergent (pH 9/10) dilution according manufacturer instruction, let it work during 1 minute and sweep with a white clean cloth.
PERIODICAL CLEANING	ACTIONS	INSTRUCTIONS
	<b>1. Light soiling</b>	– Machine cleaning: use a scrubbing machine fitted out with soft white brushes or red pads at medium speed – Use detergent neutral or alkaline (pH 7/9)
	<b>2. Heavy soiling</b>	– Apply a cleaning solution (pH 10-11, after dilution) to the flooring and allow to act for 5-10 min. – Machine cleaning: use a scrubbing machine fitted out with soft white brushes or red pads at medium speed. – Vacuum up the soiled water immediately. – Rinse with clean water and allow the floor to dry.
	<b>3. Stain removal</b>	– For stubborn stains on the floor, use an alkaline detergent (pH 9/10) dilution according manufacturer instruction, let it work during 1 minute and sweep with a white clean cloth.



# TAPIFLEX STAIRS TENDER SPECIFICATION

The selected flooring similar to Tapiflex Stairs belongs to the acoustic vinyl floors category under the EN standard 649, available in 2m wide sheet with a Group T wear rating.

**The product formulation does not contain phthalate based plasticizer.** It is built on a calendered backing layer made of recycled vinyl flooring material. It contains over 20% of recycled material.

It is an all-in-one stair covering comprising the stair tread, a ribbed nosing in a contrasted colour and the stair riser.

The product is built with a high density foam backing reinforced with glass fibre and a high quality printed design.

The **wear layer of 1mm** is reinforced with a UV photo crosslinked polyurethane including particles of alumina TopClean XP™ treatment, which permanently suppresses any wax and regenerating polish spray maintenance operations.

It has an **acoustic performance of 18dB and a static indentation resistance ≤ 0,20mm.**

Its emission rate of volatile organic compounds in air is very low, measured after 28 days according to EN 16516 standard. Close to zero emission (quantification limit), TVOC, TSVOC and formaldehyde emissions are below than 10 µg / m³.

It is free of formaldehyde and is 100% REACH compliant.

It is 100% recyclable and installation off-cuts can be collected and recycled in new products through the Tarkett ReStart® program.

Tapiflex Excellence comes with a 10 Year Warranty.

## More excellent reasons to choose Tarkett Stairs

- ✓ 100% Phthalate Free
- ✓ No formaldehyde
- ✓ 100% recyclable
- ✓ Test reports and certificates available upon request
- ✓ Optimal indoor air quality
- ✓ TVOC ≤10 µg/m³ after 28 days
- ✓ FloorScore® certified
- ✓ ISO 14001 certified production site
- ✓ REACH Compliant and CE Marking

# TECHNICAL DATA SHEET

## SPECIFICATION DATA

The Tapiflex Stairs range, with its 22 decors, offers one of the most performing heavy-traffic heterogeneous vinyl stairs solutions on the market. The range is 100% Phthalate-Free and the VOC air emission rate is very low; less than 10µg/m³. The range includes a glue-down solution (18dB) and a self-adhesive solution (18dB) available in 10 decors, both in roll format and with a 10 year warranty.

TECHNICAL DATA	STANDARD	TAPIFLEX STAIRS	TAPIFLEX STAIRS SELF-ADHESIVE
<b>CLASSIFICATION</b>			
<b>Classification</b>	EN 651 EN ISO 10874	Heterogeneous Acoustic Vinyl 34-43	Heterogeneous Acoustic Vinyl 34-43
<b>Wear Group</b>	EN 660-2	T	T
<b>TECHNICAL CHARACTERISTICS</b>			
<b>Total thickness</b>	EN ISO 24346	3.50 mm	3.50 mm
<b>Total weight</b>	EN ISO 23997	3670 g/m²	3670 g/m²
<b>Wear layer thickness</b>	EN ISO 24340	1 mm	1 mm
<b>Form of delivery</b>	EN ISO 24341 (rolls)	approx. 23 running metres x 102 cm	approx. 23 running metres x 102 cm
<b>PERFORMANCES FOR CE MARKING REQUIREMENTS (EN 14041)</b>			
<b>Declaration of Performance</b>	EN 14041	0120-0025-DOP-2013-04	0120-0069-DoP-2014-12
<b>Reaction to fire</b>	EN 13501-1	B <sub>fl</sub> -s1 glued over any A2 <sub>fl</sub> or A1 <sub>fl</sub> substrate (concrete) C <sub>fl</sub> -s1 glued over any derivate wood substrate	C <sub>fl</sub> -s1 glued over any A2 <sub>fl</sub> or A1 <sub>fl</sub> substrate (concrete) C <sub>fl</sub> -s1 glued over any derivate wood substrate
<b>Electrostatic properties</b>	EN 1815	≤ 2,0 kV	≤ 2,0 kV
<b>Thermal resistance</b>	EN ISO 10456	0.04 m² K/W	0.04 m² K/W
<b>Slip resistance</b>	EN 13893	µ ≥ 0,3	µ ≥ 0,3
<b>TECHNICAL PERFORMANCES</b>			
<b>Residual indentation</b>	EN ISO 24343-1	Required value: ≤ 0.20 mm Best measured value*: 0.10 mm Average measured value*: 0.17 mm	Required value: ≤ 0.20 mm Best measured value*: 0.10 mm Average measured value*: 0.17 mm
<b>Impact sound reduction</b>	NF EN ISO 717 / 2	ΔL <sub>w</sub> = 18 dB	ΔL <sub>w</sub> = 18 dB
<b>Acoustical improvement</b>	NF S31-074	L <sub>n,e,w</sub> < 65 dB - Class A	L <sub>n,e,w</sub> < 65 dB - Class A
<b>Slip resistance<sup>(1)</sup></b>	DIN 51130	R10	R10
<b>Furniture leg</b>	EN 424	No damage	No damage
<b>Castor chair</b>	ISO 4918	No damage	No damage
<b>Curl resultant to heat</b>	EN ISO 23999	≤  8  mm	≤  8  mm
<b>Light fastness</b>	EN ISO 105-B02	≥ 6	≥ 6
<b>Dimensional stability</b>	EN ISO 23999	< 0.10%	< 0.10%
<b>Chemical resistance</b>	EN ISO 26987	High resistance	High resistance
<b>Underfloor heating</b>		Suitable	Suitable
<b>ENVIRONMENTAL PERFORMANCES</b>			
<b>Total VOC emissions</b>	ISO 16000-9	≤ 10 µg/m³ (after 28 days)	≤ 100 µg/m³ (after 28 days)
<b>Formaldehyde</b>	ISO 16000-3	< 10 µg/m³ (after 28 days)	< 10 µg/m³ (after 28 days)
<b>COLOURS</b>			
		22	10

The above information is subject to modification for the benefit of further improvement. (01/18). \*For information - not binding.

<sup>(1)</sup>Please note that slip resistance may be impacted by usage and cleaning operations.

According to the European Regulation N° 305/2011 for CE Marking, the Declarations of Performance are available on our website [www.tarkett.com](http://www.tarkett.com)

Tarkett's instructions regarding installation, cleaning and maintenance should be observed. Please contact Tarkett at the address shown for these instructions.

CUSTOMS TARIFF : 4820 5000 00



Disclaimer : Please note that products in photos are installed for creative purposes and not according to technical specifications. Please refer to Tarkett installation instructions for guidance.



